

# VOLUTION 3 PARAMOTOR

---

THE SKY'S YOUR PLAYGROUND

Welcome to your new Volution 3 Paramotor.  
You're about to embark on a dynamic  
and responsive flying experience.  
Let's get started.

## Congratulations!

Your Volution 3 paramotor is the leading paramotor of choice for training schools and recreational pilots worldwide. I guarantee you have made an excellent choice and that every effort has been made to ensure your purchase is a top-quality, thoroughly-tested design, ready to provide many years of enjoyable flights and just as many safe landings.

The Volution 3 has been designed and manufactured by our vastly experienced team of pilots, designers and engineers at our UK factory where meticulous assembly procedures and hand-built production, ensures the highest levels of quality and safety controls. Every engine is checked, fine tuned and run-up before shipment.

As a fellow pilot, I have a true passion for flying and for the sport of paramotoring and I hope that you will have as much fun and exhilaration as I do.

Happy flying!!



### IMPORTANT:

Because some of the features and guidelines for using your Volution 3 paramotor merit close attention, it is very important that you familiarise yourself with the paramotor by reading this entire manual before use. If you have any questions, please contact an Authorised Parajet Dealer or check the Parajet website at [www.parajet.com](http://www.parajet.com).

## Introduction

Your Volution 3 paramotor is shipped 95% factory-assembled. You only need to put together the protective outer cage. Once you have completed the cage assembly and you've read the safety guidelines you're ready to get flying. Assembly should take 2-3 minutes and requires no tools. Before any flight, be sure you carry out a comprehensive 'harness to hub' safety check and have a thorough understanding of the paramotor's features and operation.

**NOTE:** Any reference to left or right and front or back is made in the direction of travel, as if you were sitting in the harness facing forward with the paramotor on your back.

### WARNING:

**YOU MUST READ THIS MANUAL AND AGREE TO THE CONDITIONS OF USE BEFORE USE.** You will use the Volution 3 paramotor at your own risk. Due to the inherent risk in flying any motorised paraglider, no guarantee of any kind can be made against accidents, bodily injury and/or death. Be sure to make all required checks on the power unit and paraglider before every flight. Never try to fly if you find any part of your paramotor damaged or suspect a malfunction. **THIS MANUAL IS NOT A SUBSTITUTE FOR FLIGHT TRAINING. PROPER TRAINING BY A QUALIFIED INSTRUCTOR IS ESSENTIAL.**

## Safety Guidelines

Flying your Volution 3 paramotor is renowned for its safety due to the inherent stability, ease of control and resistance to stalls. It is essential that you read and understand all of the following safety guidelines - in addition to the warnings and instructions contained within this manual - prior to using your Volution 3 paramotor. Contact an Authorised Parajet Dealer or Parajet direct if any of these instructions are unclear.

- The Volution 3 paramotor is to be used only after having received adequate and proper training from a qualified paramotor instructor.
- The total weight limit of the Volution 3 paramotor is 352lbs (160kg).
- The Volution 3 paramotor should only be used with paragliders designed for paramotoring and correctly sized for the combined weight of the paramotor, pilot and cargo.
- Pilots are seriously advised to fly the Volution 3 paramotor with an adequate reserve parachute fitted. While wing failures are very rare, a reserve parachute can save your life.
- Pilots should always wear a helmet designed for powered paragliding/paramotoring. It is also advised that pilots wear adequate footwear with good ankle support and gloves.
- A pre and post flight check of your Volution 3 paramotor is essential. Inspect and maintain your equipment as outlined in the "Harness to Hub Safety Checklist" of this manual.
- The engine should only be started once the pilot has mounted the paramotor securely onto their back. Check immediate area near the propeller for lines, ropes, clothing and anything that could be caught in the moving propeller or drive pulleys.
- Always warn any persons nearby before starting the engine; Make it a habit to shout 'Clear Prop' in a loud and clear voice.
- The turning propeller can cause considerable damage and injury. Be aware and stay clear of all moving parts such as propellers, pulleys and belt. After prolonged engine use stay clear of hot engine parts and exhaust muffler.
- Before launching your Volution 3 paramotor check harness and helmet buckles are fastened and secure. Also ensure that the paraglider is attached correctly and that the karabiners are fastened securely.
- Do not fly low level over water, woodland, or potentially hazardous landing areas. Do not fly into controlled airspace or over built up areas, it essential always to consider a safe landing area should you experience difficulty.
- Always be aware of the weather. Conditions can change rapidly. Never fly if large cumulus clouds are forming and never fly in the rain.
- To maximise your fun and enjoyment, always fly the Volution 3 paramotor within your known limits and capabilities.

## Fitting the Cage Sections

The Volution 3's super-strong aerofoil cage offers strength and aerodynamic styling. The unique cage system consists of four sections and enables the protective cage to be put together in seconds, requiring no tools.

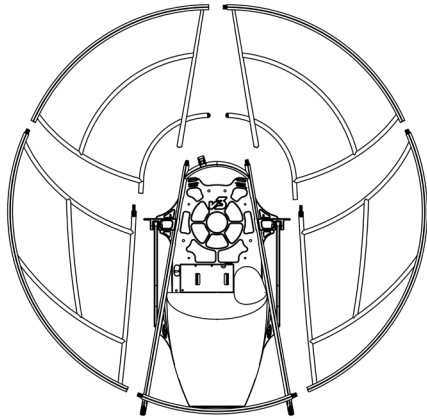

- 1 Starting with a lower cage section, insert the cage dowel into the mounting aperture located on the hinge block, making sure the cage section is curved towards the rear of the paramotor.

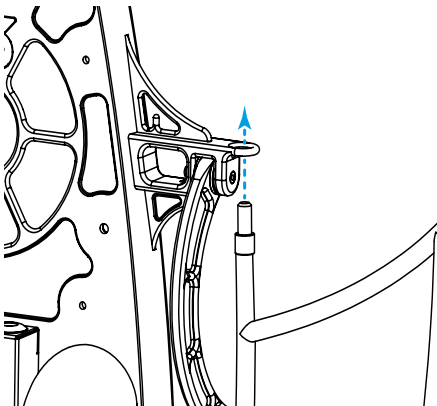

- 2 Insert the nylon connector, located at the end of each leg, into the cage section. Push the cage section until the location pin engages and secures the cage section in position.

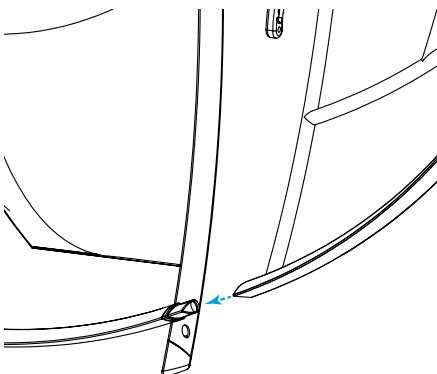

- 3 Repeat the connection procedure for the second lower cage section.
- 4 To fit the top cage section, align the cage section to the cage dowel and insert the nylon connector, located on the top of the chassis, into the cage section. Push the cage section until the location pin engages and secures the cage section in position.

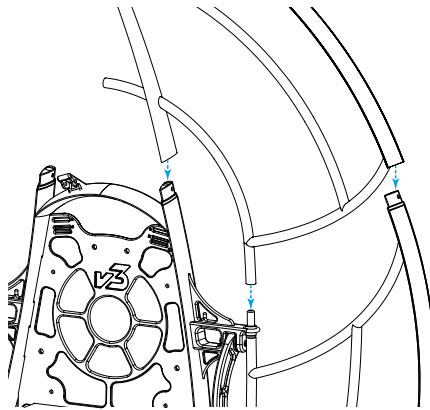

- 5 Insert the nylon connector, located on the outer ring, into the top cage section. Push the cage section until the location pin engages and secures the lower and top cage sections together.
- 6 Repeat the connection procedure for the second top cage section.
- 7 Finally, insert the nylon connector, located at the top of the outer ring, into the top cage section. Push the cage section until the location pin engages and secures both top cage sections together.

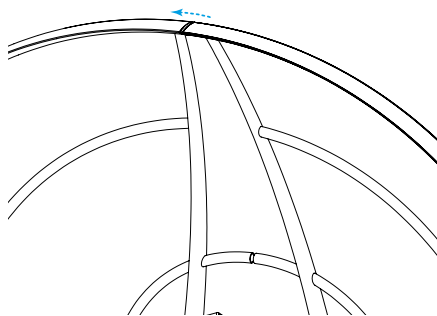

## Propeller Assembly & Attachment

The propeller for the Volution 3 can rotate in either a clockwise or anti-clockwise direction when looking at the paramotor from the rear. This is crucial when fitting the propeller to the hub, please check your engine manual for more information.

- 1 Lay the two propeller blades on the ground while orientating the blades so that the 'Parajet' propeller stickers are facing upwards (a).
- 2 Slide the two propeller blades together ensuring that the mounting holes align correctly (b).

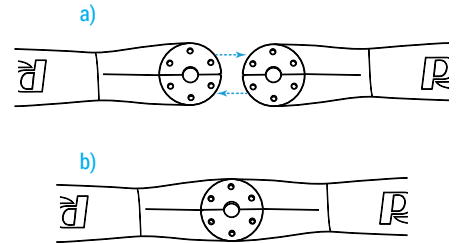

- 3 Insert the six propeller bolts into the propeller plate. Align the bolts with the mounting holes and insert into the propeller.

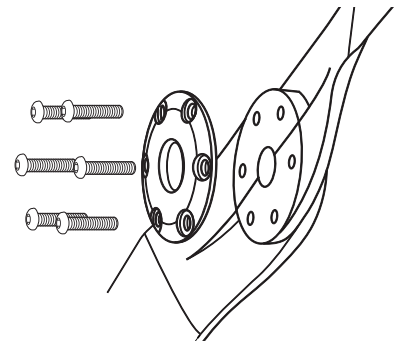

- 4 Wrap your hand over the top of the propeller plate and bolts. Picking up the propeller, align the propeller bolts to the mounting holes on the hub.
- 5 Tighten the bolts to 10nm in a diagonal, opposing pattern. Do NOT over tighten as this can cause damage to the propeller.

## Weight-shift harness adjustment

The Parajet paramotor harness is a low hang point system. Parajet has always been a strong advocate of the low hang point attachment and it has been a permanent feature throughout their range of paramotors.

Parajet's innovative design offers improved wing feedback and an optimised thrust line while removing the normal swing or rocking motion found under throttle.

This combination of low hang point attachment and articulated pivot arms culminates in the ability for the pilot to control direction without the ongoing control input. Known as weight-shift, this dynamic feature works through the pilot's weight effecting the orientation of the pivot arms, which in turn provides input into the wing. Weight-shift enables pilots to emanate the agile characteristics of free-flight with manoeuvrability so precise, that the paramotor feels like an extension of their body.

**IMPORTANT:** To achieve the best flying characteristics of the harness it is important that you spend time to fully understand the adjustment system and set it up for your optimum weight setting. Failure to do this accurately will result in poor handling, an uncomfortable flying experience and could lead to a potentially hazardous accident.

The harness should be adjusted to suit both your physique and flying style. It is important to adjust it correctly to ensure you can easily slide into the sitting position after take-off.

While we have endeavoured to provide concise and accurate instructions for harness adjustment, we recommend that these be tested before your first flight by hanging in a simulator with the aid of a qualified paramotor instructor.

Due to the dynamic nature of the harness, additional fine-tuning of adjustments maybe required during your first few flights to ensure optimum comfort.

## Pilot weight adjustment guide

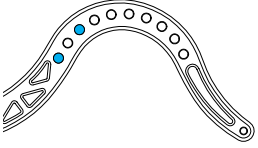
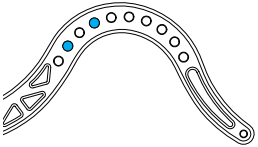
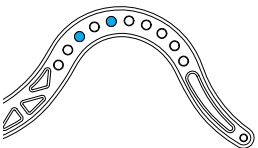
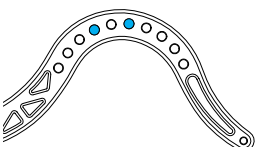
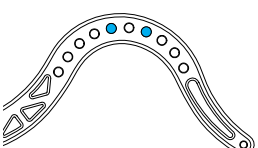
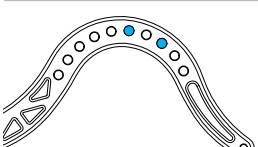
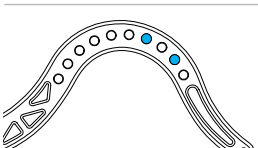
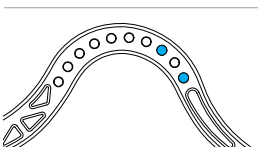
	<b>Moster 185</b> 50kg - 60kg
	<b>Moster 185</b> 60kg - 70kg <b>Atom 80</b> 60kg - 70kg
	<b>Moster 185</b> 70kg - 75kg <b>Atom 80</b> 70kg - 75kg
	<b>Moster 185</b> 75kg - 80kg <b>Atom 80</b> 75kg - 80kg
	<b>Moster 185</b> 80kg - 85kg <b>Atom 80</b> 80kg - 85kg
	<b>Moster 185</b> 85kg - 100kg <b>Atom 80</b> 85kg - 90kg
	<b>Moster 185</b> 100kg - 110kg <b>Atom 80</b> 90kg - 100kg
	<b>Moster 185</b> 110kg - 120+kg <b>Atom 80</b> 100+kg

**NOTE:** The above pilot weights are for reference and as a starting point only. We highly recommend you undertake a hang-test with a qualified instructor to finalise your preferred settings before flight.

## Adjusting the harness offset pins

The Parajet paramotor harness is shipped with the offset pins already attached to the pivot arms. Always ensure the offset pins are installed on the correct side of the pivot arm for your engine.

<b>Thor 130</b>	<i>Left-hand</i>
<b>Thor 190</b>	<i>Right-hand</i>
<b>Thor 200</b>	<i>Left-Hand</i>
<b>Thor 250</b>	<i>Left-Hand</i>
<b>Top80</b>	<i>Left-Hand</i>
<b>Minari</b>	<i>Right-hand</i>
<b>Moster</b>	<i>Right-hand</i>
<b>Bailey V5</b>	<i>Right-hand</i>

- 1 To adjust the offset pins, unfasten the 6mm attachment bolts from the pivot arm.
- 2 Locate the offset pin to the desired position on the pivot arm based on your weight range (see guide above).
- 3 Secure the offset pin in place using the attachment bolts, tightened to 20 Nm.

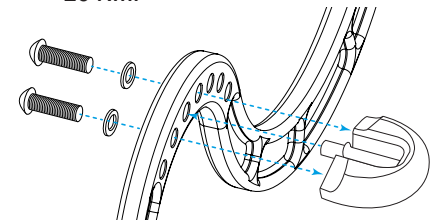

## Adjusting the harness straps

The Parajet paramotor harness has been designed to offer maximum adjustment to give you many hours of comfort, freeing you up to enjoying your flying. The harness should be adjusted to suit your physique and flying style. It is important to adjust the harness correctly to ensure you can easily slide into the sitting position after take-off. Before making any adjustments, loosen all straps and webbing.

### Leg Straps

Correct adjustment of the leg straps enables you to easily deploy the seatboard and reach the sitting position after take-off without using your hands. In the standing position, use the quick-release buckle to secure each strap around the thigh. Symmetrically adjust the leg straps using the handle loops so that they fit comfortably without being tight.

### Waist Strap

The waist strap adjusts to give you a variable level of movement within the harness. The waist strap may also be adjusted in flight according to the conditions; for example, it may be tightened in turbulent air and flown at a looser setting in less turbulent conditions to allow for easier weight shift.

### Chest Strap

The chest strap can be moved up and down the shoulder straps. Adjust the position of strap to fit across the upper part of your chest. Then fasten the quick-release buckle and adjust the length to take some lateral tension off the shoulders.

### Shoulder Straps

The optimum setting for the shoulder straps depends on your height. Stand upright with the chest and leg straps fastened and symmetrically adjust the shoulder straps using the handle loops until the straps are a snug fit, but not over tight. To confirm correct adjustment squat down into the harness, the seatboard should deploy automatically.

### Lateral Comfort Straps

The lateral straps adjust to stabilize the weight of the paramotor when not in the seating position. Symmetrically adjust the comfort straps using the handle loops until the paramotor rests comfortably on your torso.

### Seatboard Straps

The seatboard straps change the depth of the seat. Adjust to find a comfortable position. Lengthening the straps helps you to slide easily into the harness at take off, while shortening the straps helps you to be in the standing position for landing.

## Fueling your paramotor

The Volution 3 paramotor uses a 2-stroke petrol engine that requires a mixture of oil and fuel in the ratio of 1:50. Therefore you need to add 20cc (or ml) of synthetic oil for each litre of fuel.

Your engine has been designed to use regular unleaded gasoline with a pump octane number  $[(R+M)/2]$  of 95 or higher. We recommend the use of Castrol Power 1 Racing 2T and Mobil 1 Racing 2T or equivalent fully synthetic 2-stroke oil.

**NOTE:** The nature of the carbon deposits on the cylinder head, spark plug and exhaust port give important information about the fuel mixture burning in your engine. Remember that mixes that contain too much or too little oil do not extend the engine's life.

### WARNING:

Gasoline and gasoline vapors are extremely flammable. To avoid fires and explosions and to reduce the risk of injury, never re-fuel while smoking, or while in the vicinity of sparks, open flames, or other sources of ignition. Carry out re-fuelling operations in a well ventilate place and with the engine switched off. Always make sure that the fuel cap is properly fitted after re-fuelling.

## Carburettor Settings

The engine utilises a carburettor which atomises the fuel, controlling its mixture with air, and regulating the intake of the air-petrol mixture into the engine.

The carburettor can be effected by climatic conditions causing it to behave differently and therefore will require adjustment in order to ensure a smooth running engine.

The engine is shipped with the carburettor set to a default factory setting suitable for general use and will ensure plenty of fuel is entering the engine. If the engine is performing well under this factory setting, then it is possible you will not need to make any adjustments.

**NOTE:** It is important to thoroughly read and understand the carburettor settings and adjustment, as outlined in the engine manufacturer's user manual.

Failure to understand these procedures may lead to incorrect or dangerous settings and can cause irreparable engine damage and invalidates the engine and paramotor warranty.

## Getting into the harness

- 1 Before getting into the harness, attach hand control to the pivot arm, loosen the shoulder straps and ensure leg, waist and chest buckles are unfastened. Ensure straps are untangled and positioned to aid you in locating them once in the harness.

- 2 Drop onto your knees with the harness behind you. Shuffle backwards until the seatboard is pressed against your upper legs.
- 3 Fasten both leg straps using the quick-release buckles. Slip both arms into the shoulder straps before fastening the waist and chest straps.
- 4 Lean forward onto both hands. Bring your left knee to your chest so that your foot is flat on the ground. Repeat the same with the right foot, using your hands to steady yourself.

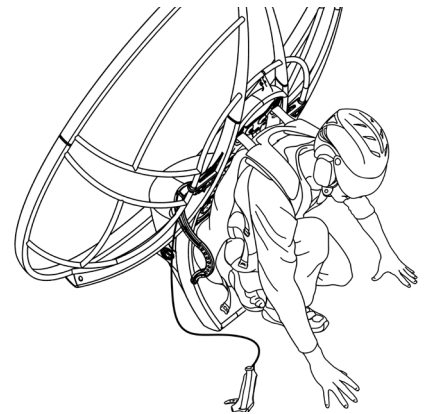

- 5 Keeping your body tight, straighten yourself upright while driving through your heels, keep the balls of your feet on the ground as well, until you are in the standing position.
- 6 Tighten the shoulder straps using the handle loops until the straps are a snug fit, but not over tight. To confirm correct adjustment squat down into the harness - the seatboard should deploy automatically.

## Prior to starting the engine

We recommend that you do not run your Parajet Volution 3 paramotor while placed on the ground. Be sure to choose a flat area of ground which is well ventilated. Do not start the engine indoors or in other poorly ventilated areas.

**NOTE:** Experience has proven that it is much safer to carry out all pre-flight power checks with the paramotor firmly strapped on your back.

- 1 Conduct a thorough pre-flight inspection as outlined in the "Harness to Hub Safety Checklist" of this manual. Check you have an adequate level of fuel for the duration your flight.
- 2 Carry out the Six Point Check ensuring your harness and helmet buckles are fastened and secure. Also ensure that the paraglider is clipped-in correctly and that the karabiners are fastened securely.
- 3 Before starting the engine, check immediate area near the propeller for lines, ropes, clothing and anything that could be caught in the moving propeller or drive pulleys.
- 4 Always warn any persons nearby before starting the engine; Make it a habit to shout 'Clear Prop' in a loud and clear voice.

## Starting your paramotor

### Priming the Engine

- 1 To start, the engine requires the fuel system to be primed. Squeeze the priming bulb to pull the fuel into the system. To make this operation easier push softly the diaphragm nipple located on the carb.
- 2 Continually squeeze the priming bulb, stopping immediately you see the fuel reach the carburettor inlet. Failure to stop will result in the engine becoming flooded with fuel.
- 3 Squeeze the priming bulb one final time to let a small amount of fuel into the carburettor.

### Pull Start Engines

- 1 Attach the hand control to your right hand using the velcro strap.
- 2 Making sure your thumb is lightly covering the kill switch, take the pull-start handle in your left hand.
- 3 Pull the starter cord upward quickly and firmly. You may have to do this several times before the engine starts.

### Electric Start Engines

- 1 Press and hold the start button on the hand control until the engine starts. Do not hold for longer than 10 seconds. Once engine has started release start button immediately.

### Kill the Engine

- 1 Allow the engine run on idle for 60 seconds without applying any throttle. Shut off the engine by holding down the kill switch on the hand control until the engine has completely stopped.

## Warming up your paramotor

Before starting the engine it is important to carry out the Six Point Check ensuring your harness and helmet buckles are fastened and secure. Also ensure that the paraglider is clipped-in correctly and that the karabiners are fastened securely.

**NOTE:** Experience has proven that it is much safer to carry out all pre-flight power checks with the paramotor firmly strapped on your back.

Run up your Parajet Volution 3 paramotor as instructed below to ensure that the engine and transmission are warmed up correctly and to ensure continuous reliability in the future.

- 1 Unfasten the hand control from the pivot arm and attach it to your right hand using the velcro strap.

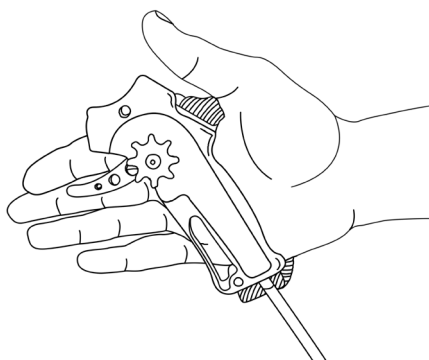

- 2 Check your immediate area in a 360 degree arc to make sure any persons are at a safe distance. Always warn any persons nearby before starting the engine; Make it a habit to shout 'Clear Prop' in a loud and clear voice.

- 3 Making sure your thumb is lightly covering the kill switch, start the engine using the pull-start handle or by pressing the start button if your engine is fitted with an electric starter. Allow the engine run on idle for a couple of minutes without applying any throttle.
- 4 Place a foot out in front of you to brace yourself against while gently accelerating and with varying power output intensity. Run the engine in this way for five minutes to ensure the engine reaches optimum operating temperature.

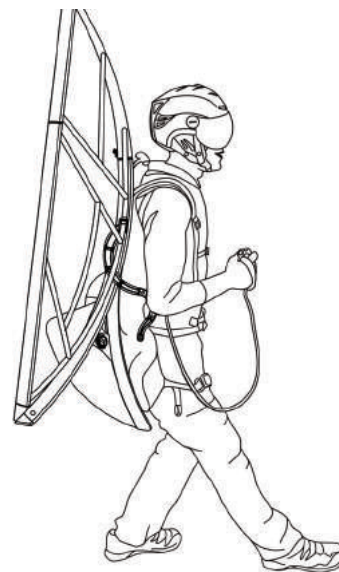

- 5 The turning propeller can cause considerable damage and injury. Be aware and keep persons at a safe distance. After prolonged engine use stay clear of hot engine parts and exhaust muffler.

**NOTE:** During your first flights or for the first 20 litres of fuel we suggest not keeping the engine at the maximum RPM for extended periods of time. We suggest varying the engine's RPM and utilising the entire rev range. This running in procedure should be carried out every time you change one of the following parts: piston, rings, cylinder, crankshaft or main bearings.

# Parajet 'Harness to Hub' Pre and Post-Flight Safety Checklist

Flying your Parajet Volution 3 paramotor is renowned for its safety due to the meticulous assembly procedures and small batch production, which ensures the highest level of quality and safety control. However, it is good practice that you carry out a thorough check of your equipment both before and after **EVERY** flight.

The Parajet 'Harness to Hub' Safety Check should only take **around 10 minutes to complete**. These checks will help you familiarise yourself with your Volution 3 paramotor and enable you to identify wear and tear or any potential mechanical problems while safely on the ground. Should any issues occur during your Parajet 'Harness to Hub' Safety Check it is highly recommend that you **DO NOT** start the engine or attempt to fly your paramotor until you have had the chance to make adequate repairs or fit replacement parts. You do so at your own risk.

## 1. Harness

- Check all webbing and stitching for wear or damage.
- Check the harness attachment points are secured to the chassis and free from excessive wear.
- Check the seat board is secure and free from wear or damage.
- Check the 5 main hangpoints:
  - 2 x leg straps
  - 1 x waist strap
  - 2 x karabiners.

## 2. Chassis

- Check the chassis and cage for damage and misalignment.
- Check all cage connections fit correctly and are secure.
- Check netting is tensioned correctly. Check for wear or damage.
- Check the hinge blocks, pivot arms and offsets are secure and free from wear or damage.
- Check for excessive lateral movement of the pivot arms. A small amount of movement is acceptable.

## 3. Fuel System

- Check the fuel tank attachment and fuel line connections are secure.
- Check fuel lines are in good condition - over time fuel lines go hard, crack and let air in.
- Check the fuel pickup pipe reaches the bottom of the fuel tank.

- Check the tank and lines for fuel leaks or spillages.
- Ensure there is adequate fuel for the planned flight duration.

## 4. Hand Control & Throttle

- Check throttle trigger operates smoothly when depressing and releasing.
- Check cruise control wheel operates smoothly and is complete loosened.
- Check throttle cable is free from twists and clear of wear or damage.
- Check the throttle arm, located on the carburettor, operates smoothly with a full range of movement from the idle pin through to the throttle stop.

## 5. Pull Start Engines

- Check pull cord is correctly mounted to the chassis. The pull-start handle should face towards the harness.
- Check pull cord for wear or damage.
- Check there is good compression by pulling gently on the pull-start handle. You should feel some resistance.

## 6. Engine

- Check spark plug cap is secure and has a tight seal.
- Check carburettor for any signs of fuel leaks.
- Check air filter is securely mounted to the carburettor and chassis.

- Check the cylinder head for signs of oil leaks and ensure crankcase bolts are tight.
- Check engine mounts are secure and free from wear or damage.
- Check all nuts, bolts and springs on the exhaust system are secure and that the exhaust is free from wear or damage.
- Check the exhaust silencer is clean and not coked.

## 7. Hub & Propeller

- Check the hub is fully engaged with the spline and the central hub bolt is secure. Ensure hub is free from wear or damage
- Check the propeller is fitted correctly. The propeller stickers should face toward the rear of the paramotor. Ensure the leading edge and tips are clean and free from wear or damage.
- Check propeller plate is mounted correctly and that the propeller bolts are secure.
- Check for adequate clearance between the propeller and cage ring.
- Check for excessive movement in the propeller bearings. A small amount of movement is acceptable.



## PARAJET INTERNATIONAL

Gilo Adventure Sports Ltd. 14 Chaldicott Barns, Tokes Lane, Semley, Dorset SP7 9AW UK  
Tel. +44 (0)1747 830 575 Email. [info@parajet.com](mailto:info@parajet.com) Web. [www.parajet.com](http://www.parajet.com)  
[facebook.com/parajet](https://facebook.com/parajet) [instagram.com/parajet](https://instagram.com/parajet) [youtube.com/parajet](https://youtube.com/parajet)